

System Characteristics / Structural Advantages

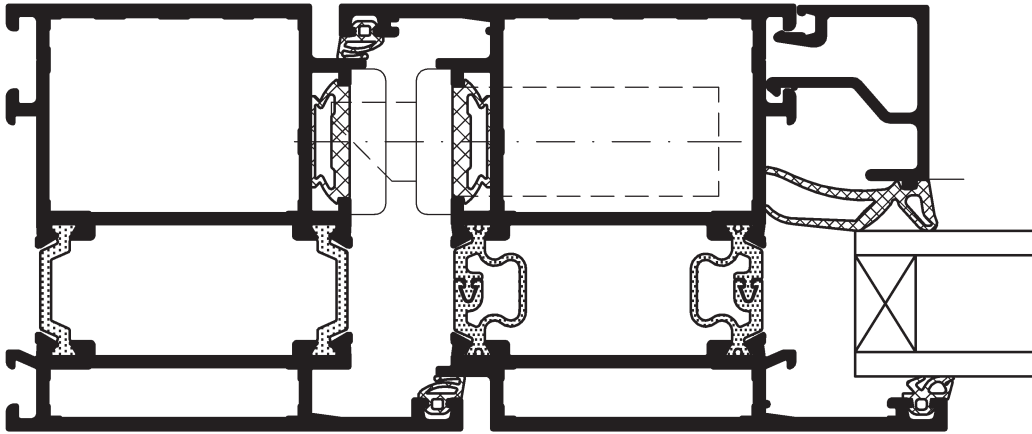

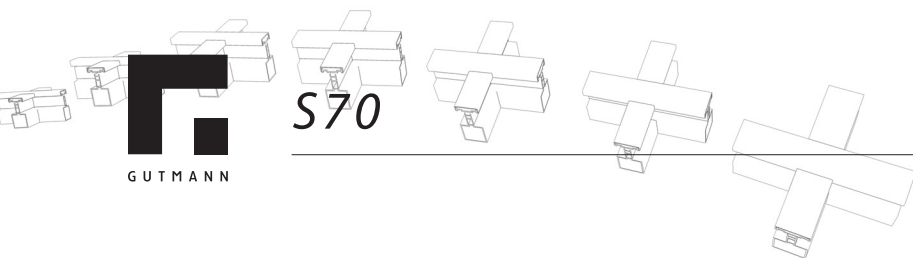



- Door series of insulated aluminium profiles single & double wing doors executable for the window series of S70.
- Profile structural depth: frame and wing 70mm
- Three-chamber system profiles, all hollow chamber pre-adjusted for same corner cleats and joint connector size.
- Insulation bridges of fiberglass-reinforced polyamide, heat-resistant to 180°C; contour of PA bridges designed for flush glazing bead
- Corner cleats and joint connectors prepared for additional and controlled glue injections, optionally for crimping or for pinning
- Glazing gaskets inside and out, of EPDM all – around; gasket profiles visually recessed for reduced gasket visibility
- Mortice locks and closing sheet metals to wedge with pre-adjusted notch and latch plate without auxiliary milling falls to frame profiles.
- Fitter and closing sheet metal is identical, 24 x 6m uniformly and for multiple bolting device
- General compatibility of profiles, accessories, gaskets and fittings to window series S70 hence fewer system accessories and reduced warehouse inventory

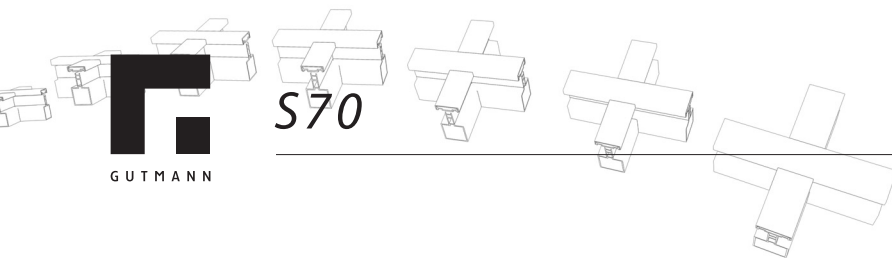

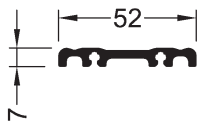
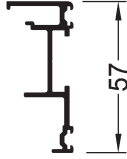
Serie	Bezeichnung	Symbol	Seite	Serie	Bezeichnung	Symbol	Seite
S70	270180 frame door inwards 75/50mm		4.1.04	S70	270302 transom 92/42mm		4.1.06
S70	270181 frame door outwards 75/50mm		4.1.04	S70	270306 transom 172/122mm		4.1.08
S70	270280 wing door inwards 75/75mm		4.1.05	S70	270380 base-156mm		4.1.07
S70	270281 wing door outwards 100/50mm		4.1.05	S70	270381 base extension profile 80/80mm		4.1.07
S70	270282 wing door for filling 50/50mm		4.1.06	S70	270382 two-way opening profile outwards 50mm		4.1.06
S70	270283 wing door inwards 75/50mm		4.1.05	S70	270383 two-way opening profile 37m		4.1.06
S70	270284 wing door outwards 100/50mm		4.1.05				
S70	270285 wing door for filling 50/50mm		4.1.06				
S60	260240 wing crossbar 60/16mm		4.1.06				
S70	270301 transom 82/32mm		4.1.06				

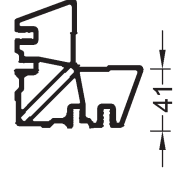
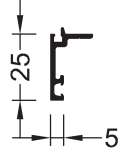

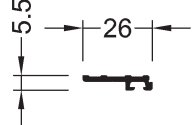
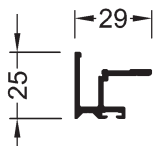
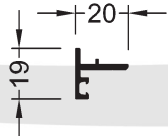
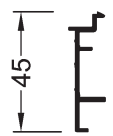
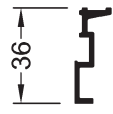
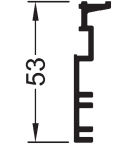
Serie	Bezeichnung	Symbol	Seite	Serie	Bezeichnung	Symbol	Seite
S70	272390 threshold 20mm		4.1.09	S70	460810 swinging-door adapter profile		4.1.09
S70	460010 sliding block		4.1.09	S70	420018 corner cleats 41mm		4.1.09
S70	460021 glass groove profile		4.1.09				
S70	460031 weatherboard		4.1.09				
S70	460801 base adapter profile		4.1.09				
S70	460802 base adapter profile		4.1.09				
S70	460803 frame extension profile		4.1.09				
S70	460805 two-way opening profile inwards		4.1.09				
S70	460806 base compensation		4.1.09				
S70	460806 base compensation		4.1.09				

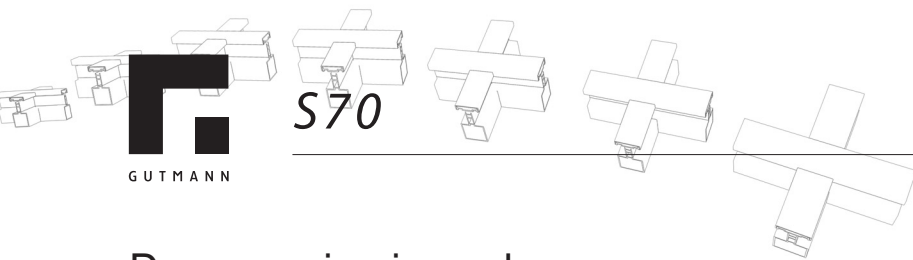

Door opening inwards

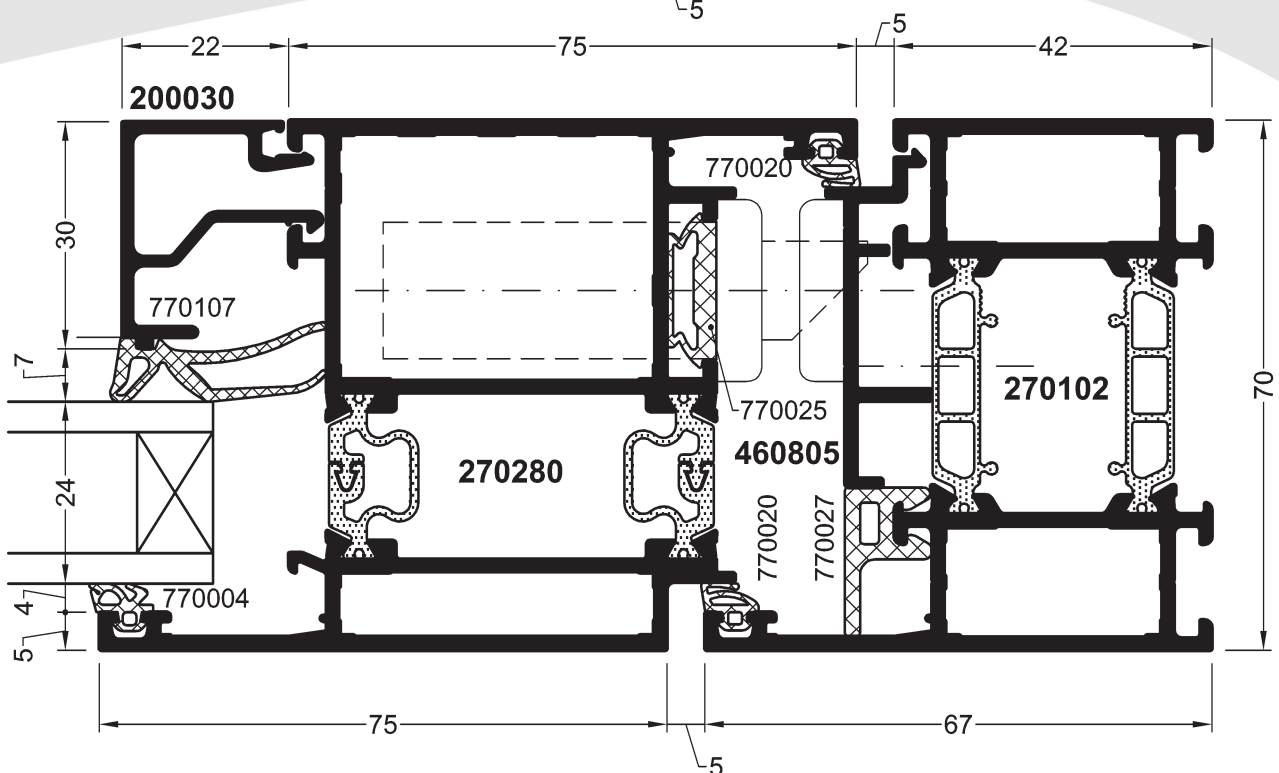
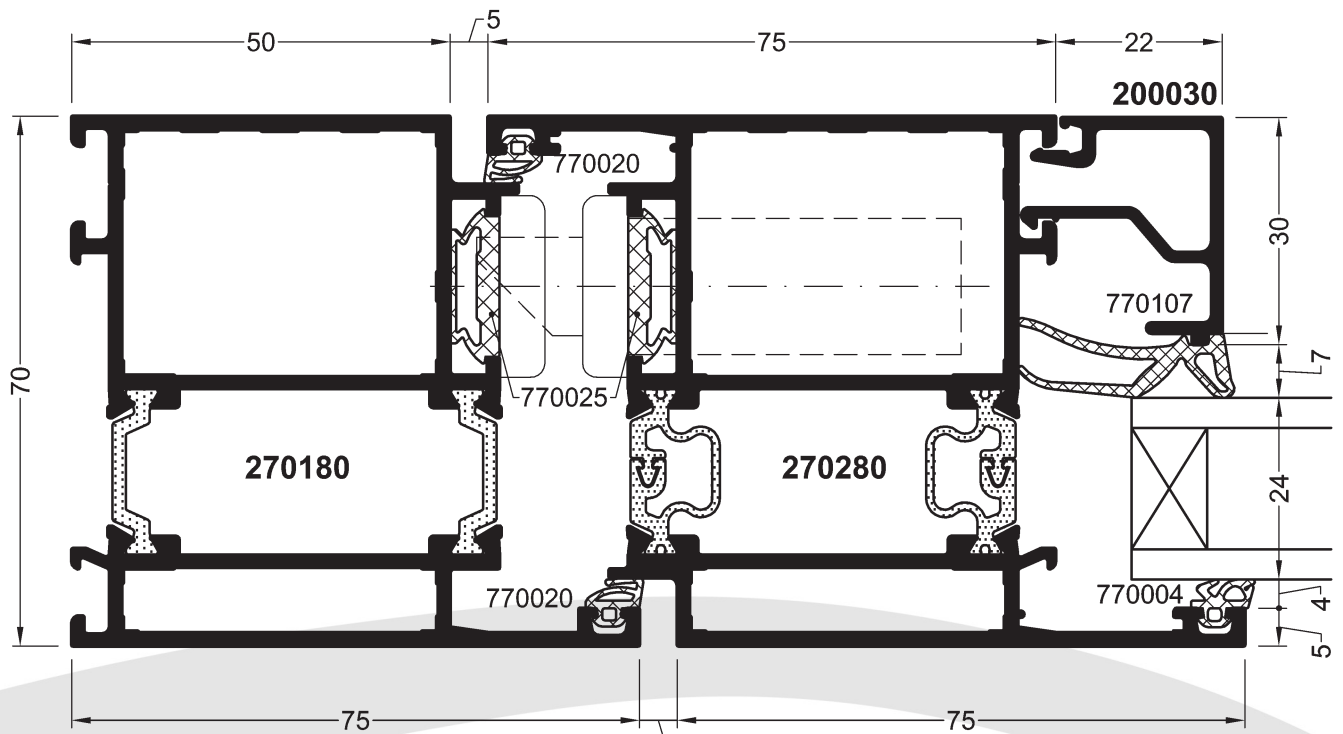
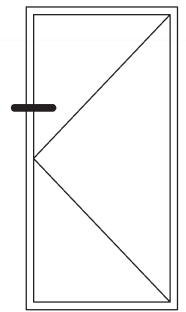

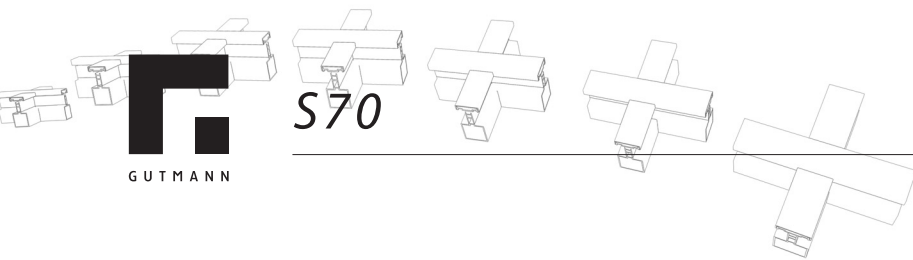

Two-way door opening

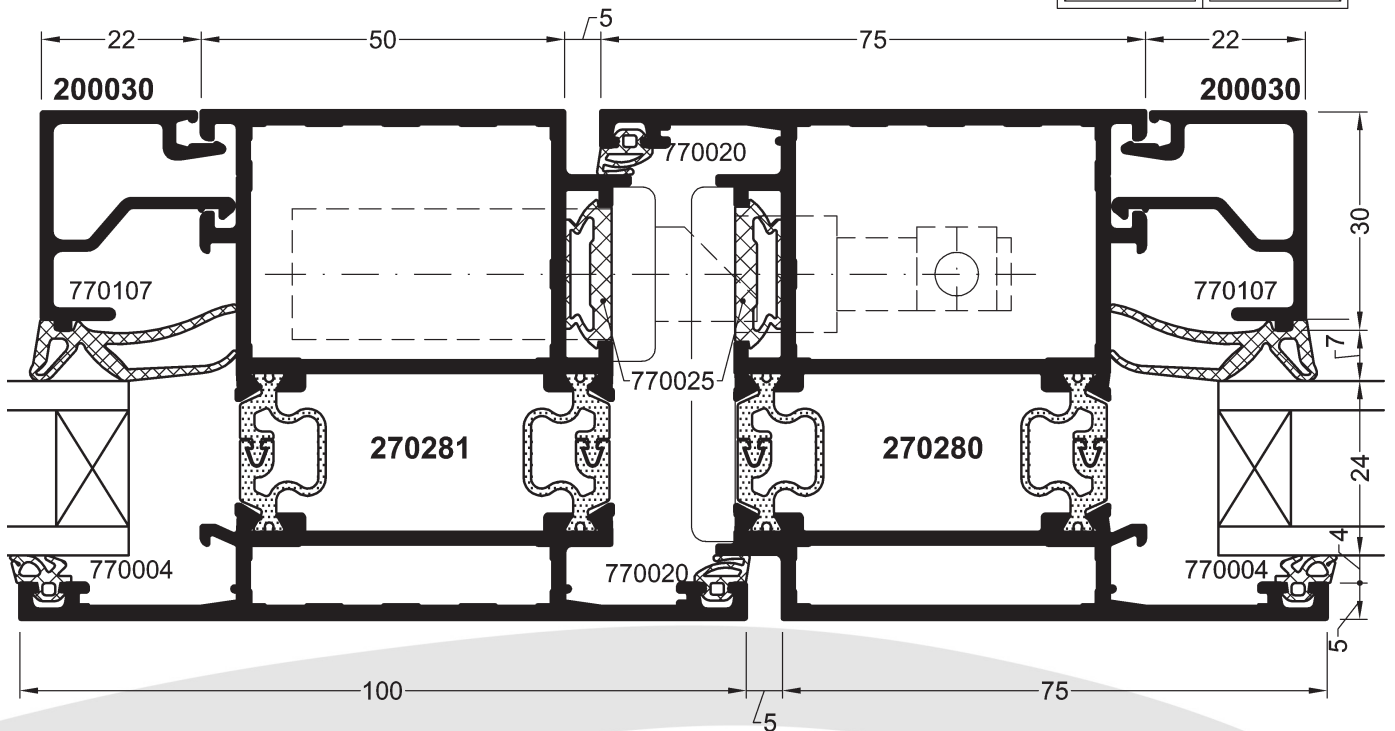
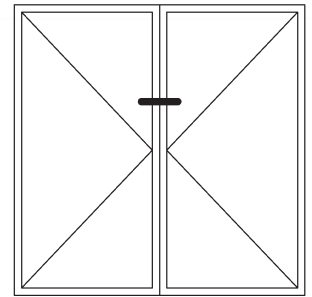

Double wing door opening outwards

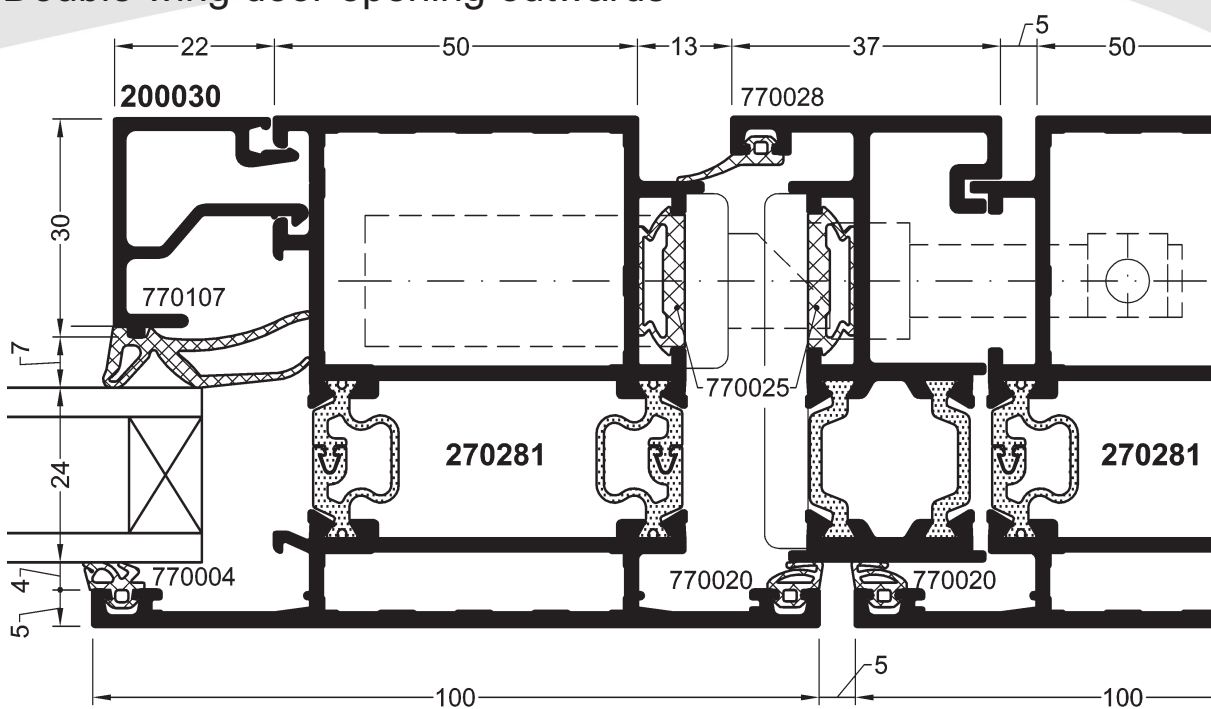

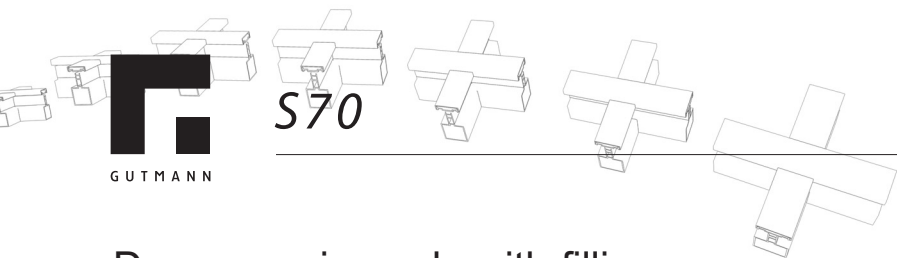

Door open inwards with filling

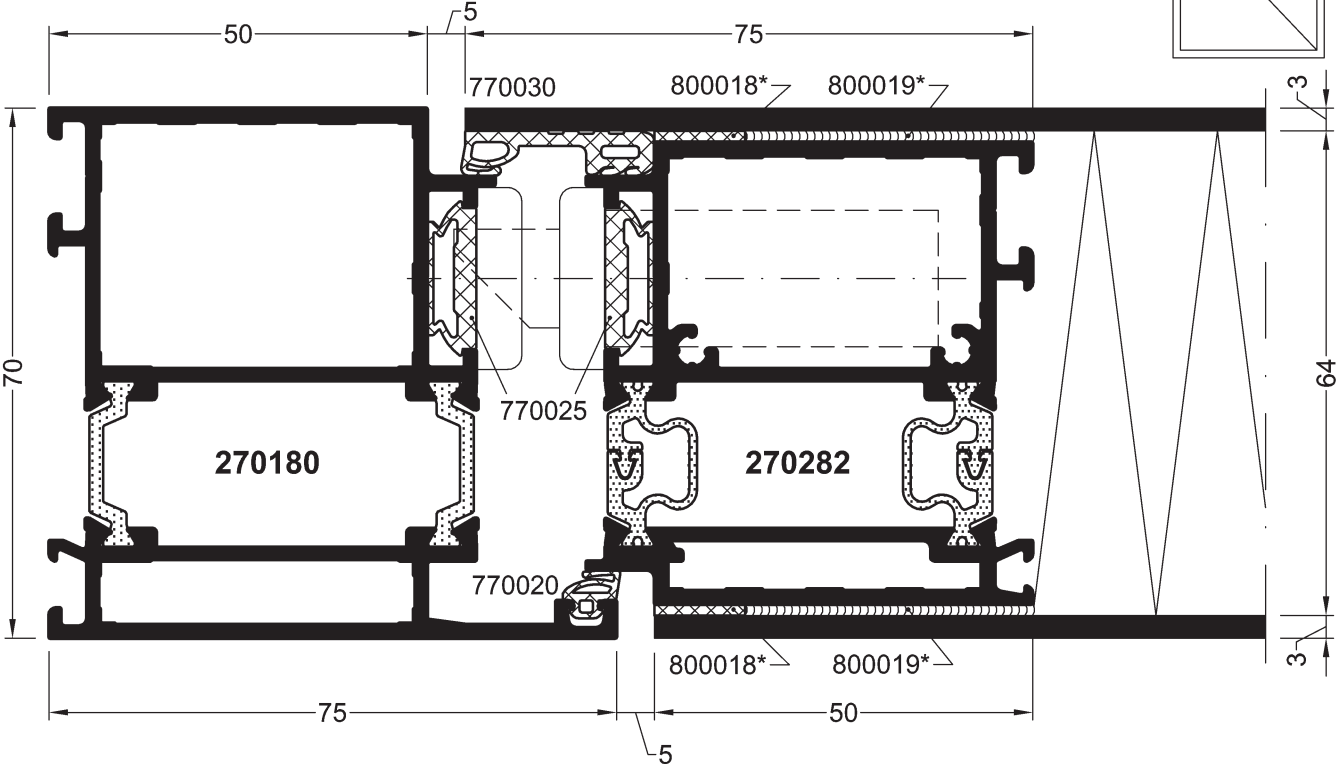
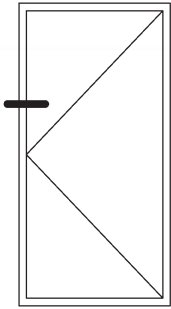

Door open outwards with filling

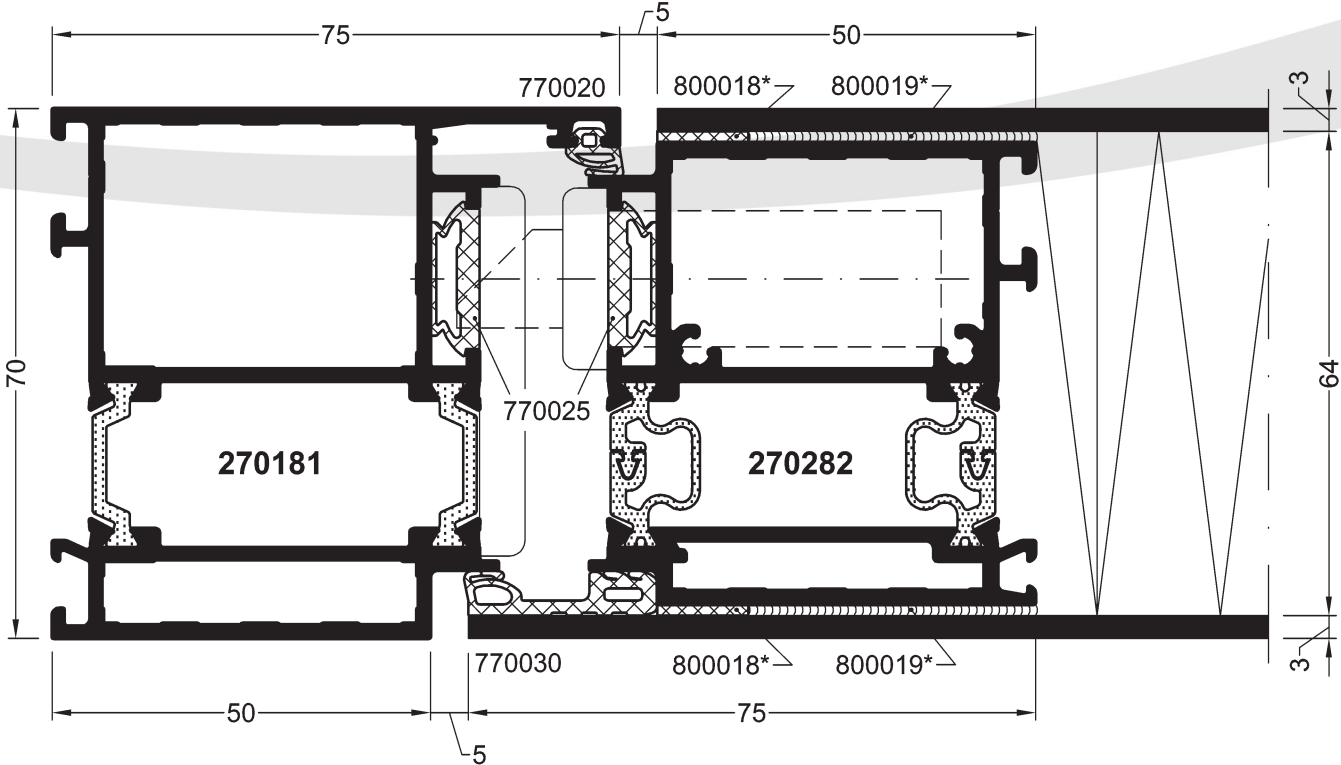

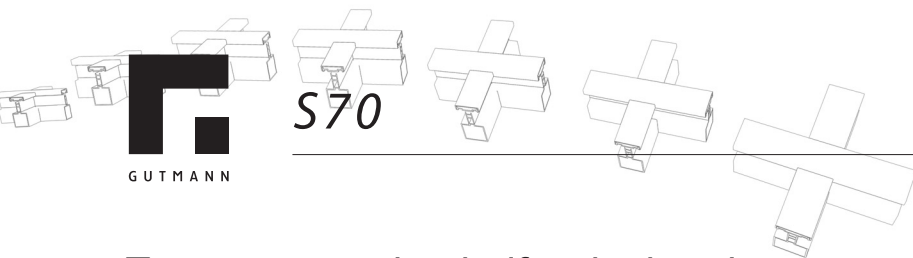

Two-way opening half swinging door with additional profile

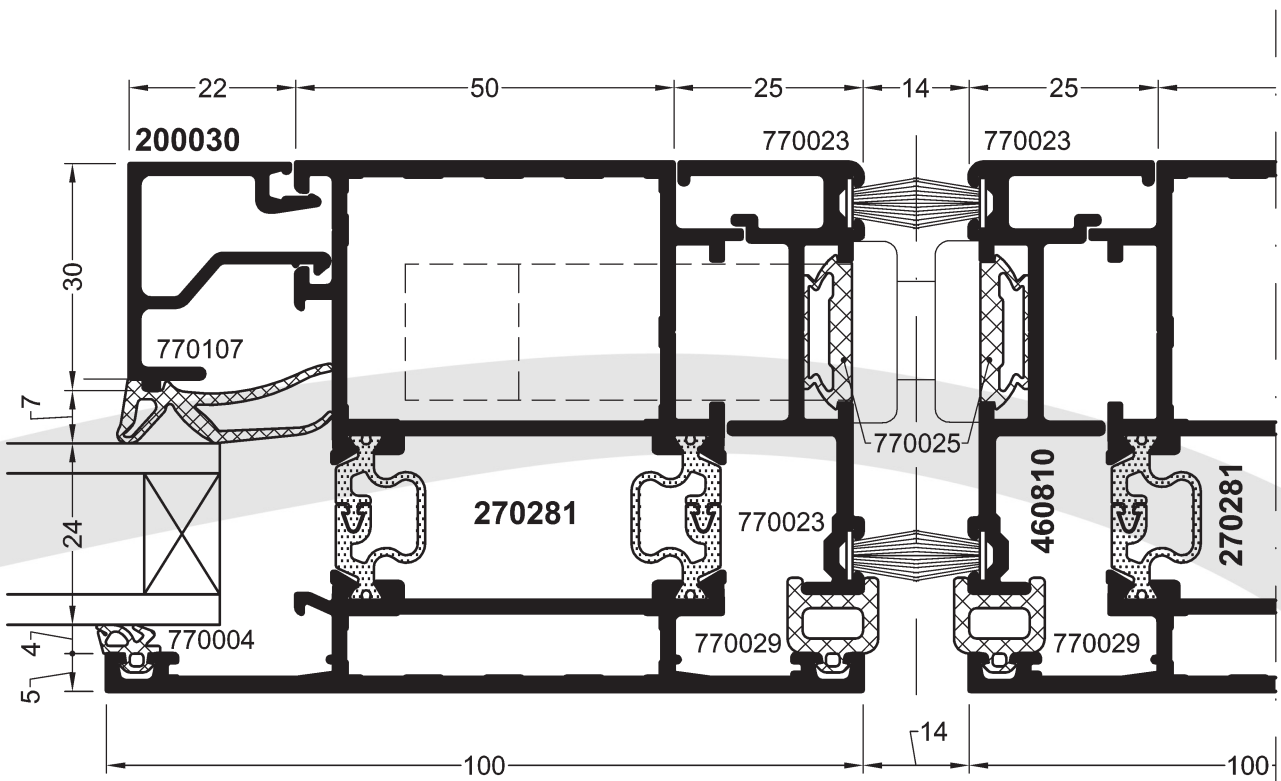
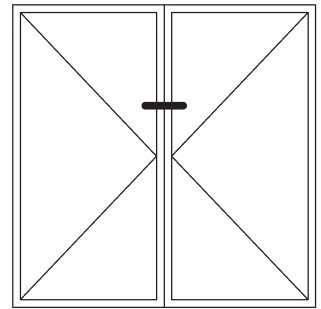

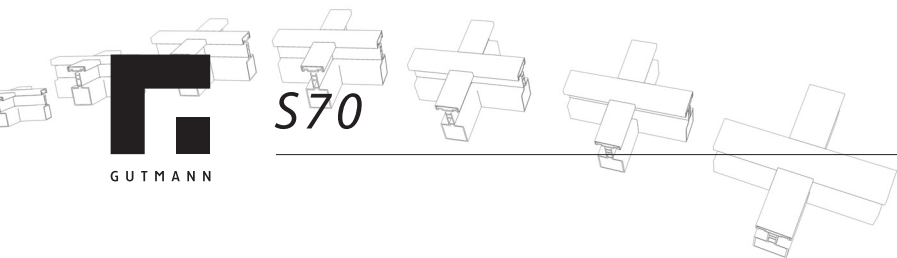

Base connection with wing profile

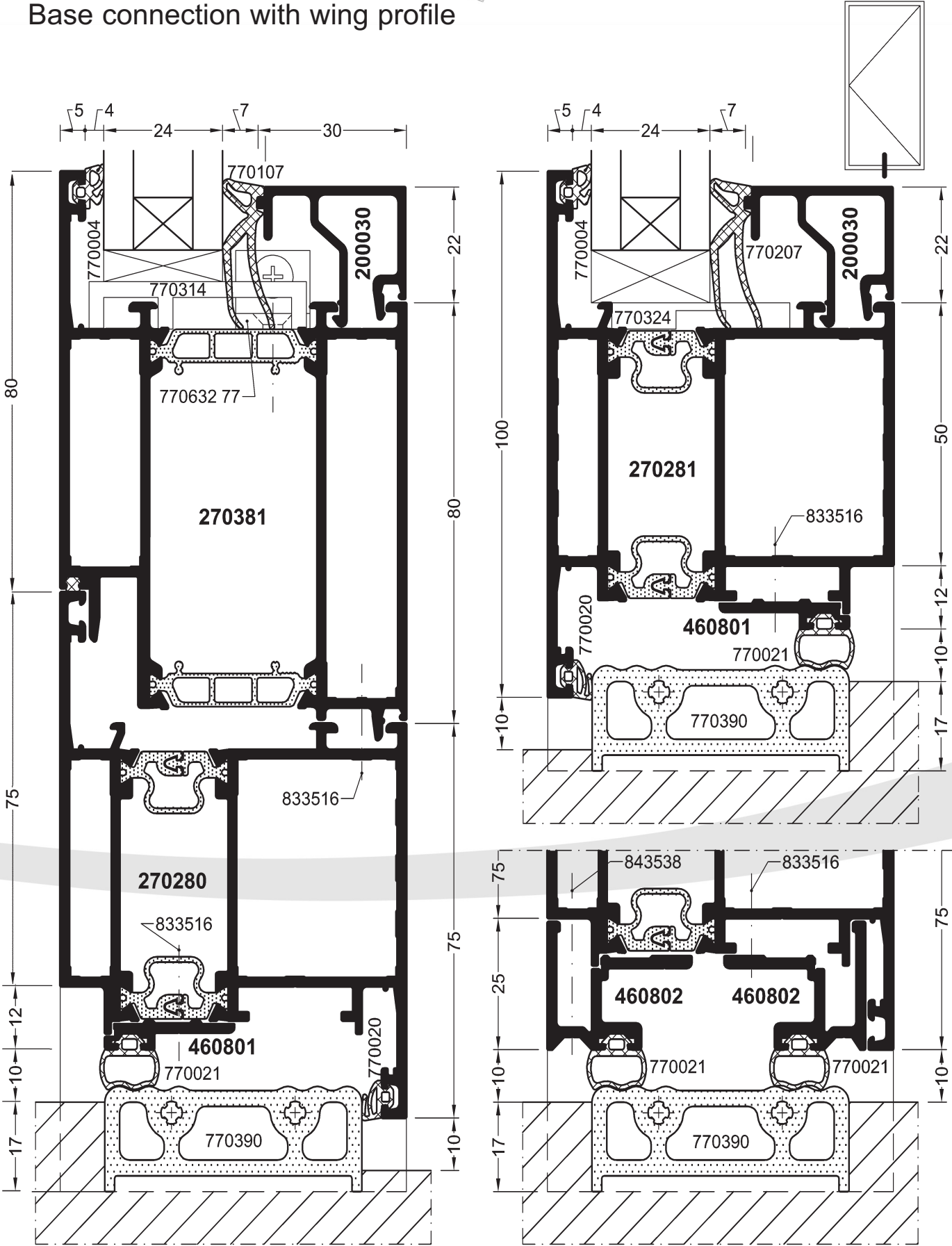

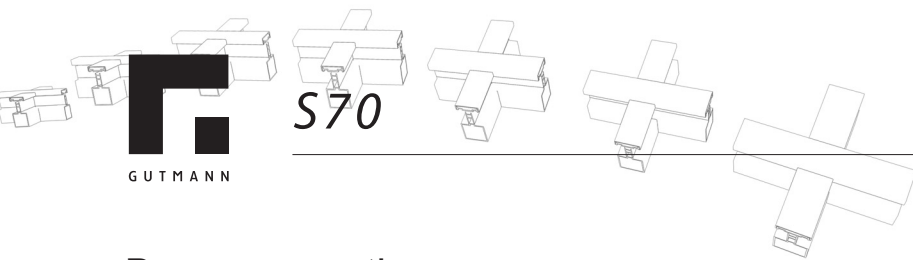

Base connection

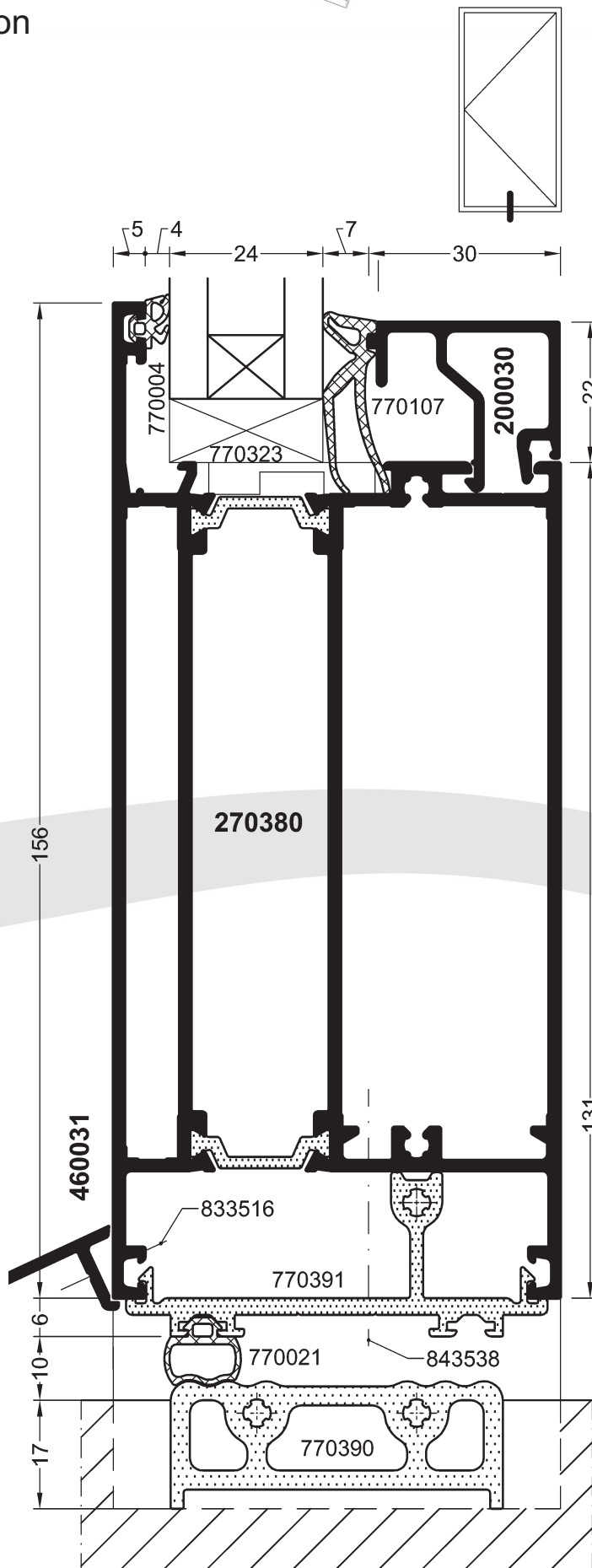

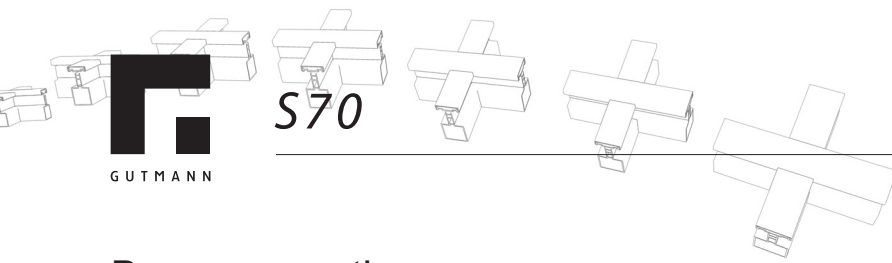

Base connection

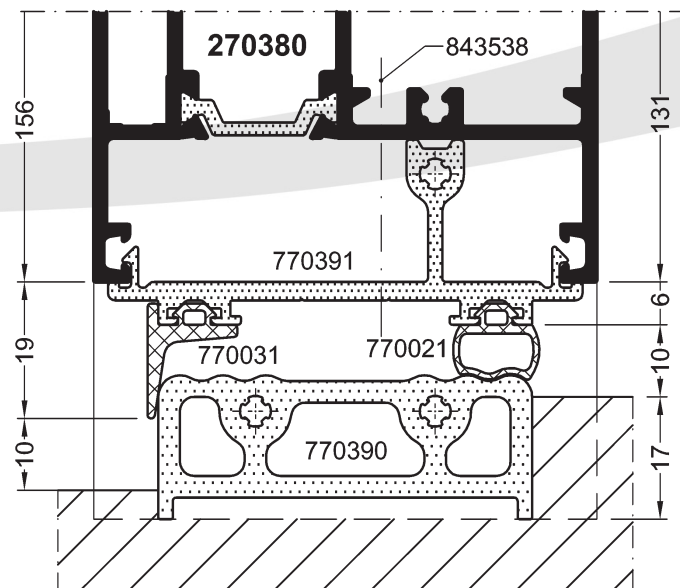
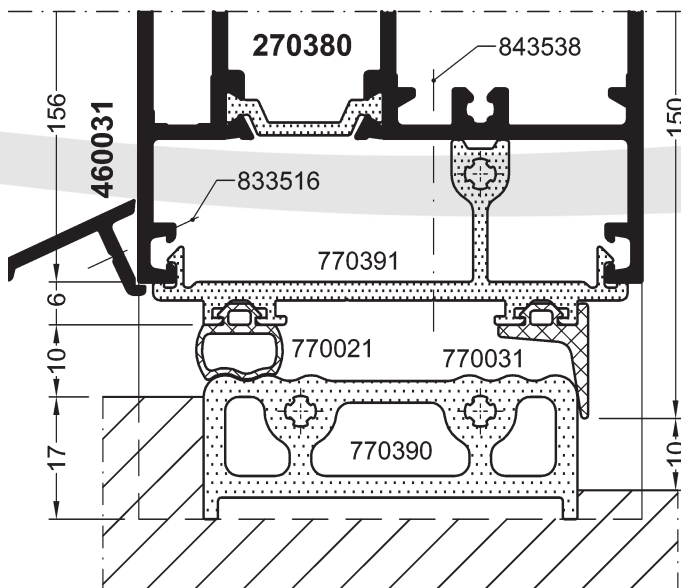
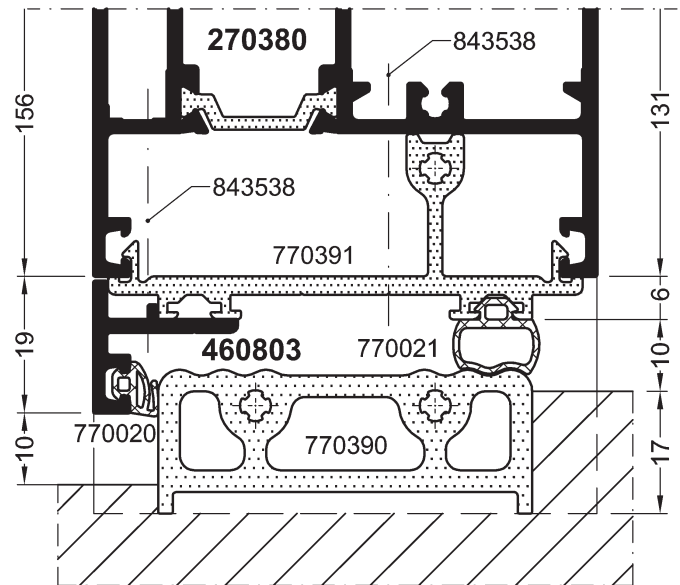
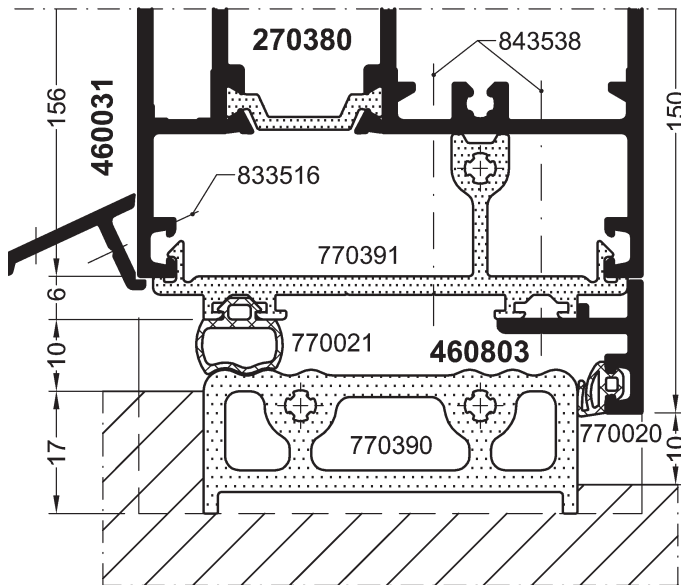
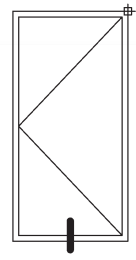

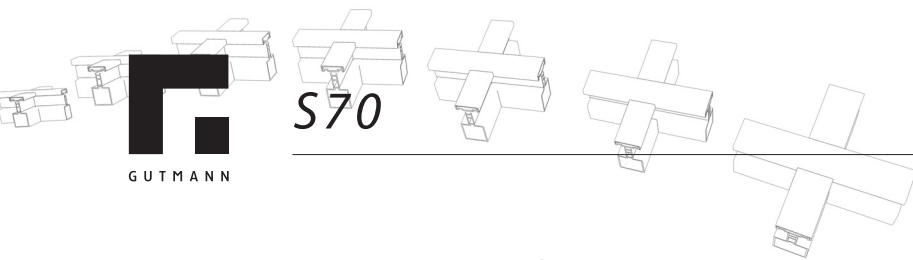

Base connection with filling

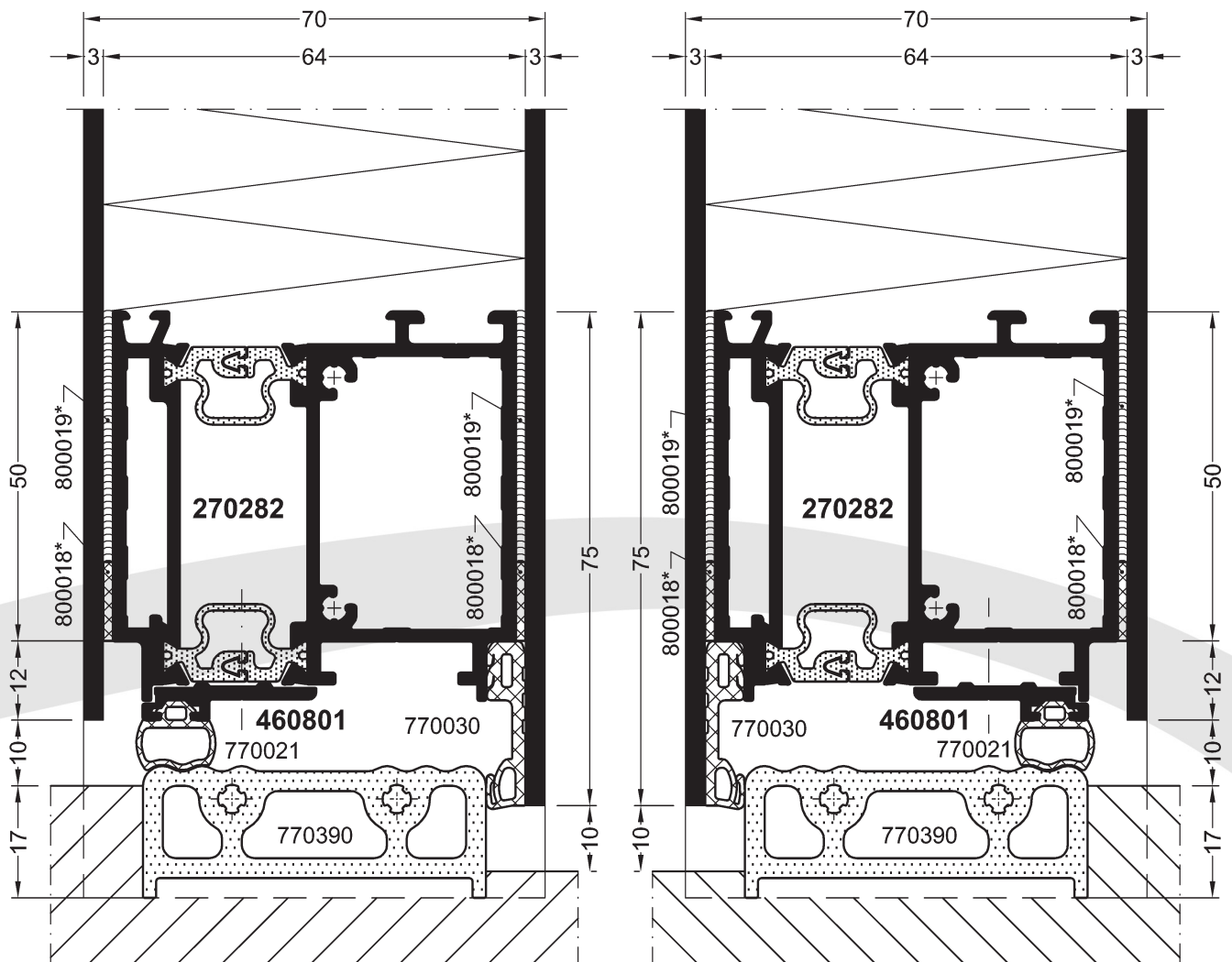
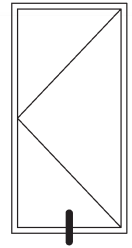

*keine Lagerware

reduced scale

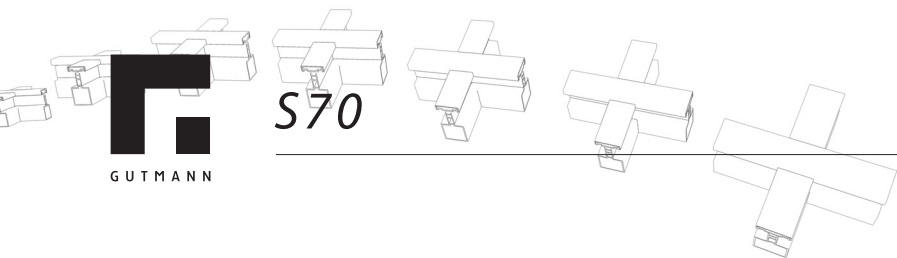

Base connection with filling

